

# ***FasTrak & Mini Z Catcher Owner's Manual***



**HUSTLER®**

.....

***Hustler Turf Equipment***

.....

*P. O. Box 7000*

...

*Hesston, Kansas*

.

*67062-2097*

## TABLE OF CONTENTS

To The New Owner.....	2
Warranty.....	4
Important Safe Operations Practices.....	5
FasTrak Frame Installation.....	7
Mini Z and Frame Installation.....	9
Attaching the Pulley.....	10
Attaching the Housing.....	11
Mounting of Pulley Guard.....	13
Attaching Chute.....	13
Operation.....	15
Parts List.....	16
Cut Out.....	20

**The operator’s manual is an important part of your new grass catcher attachment. It will help you assemble and maintain your unit for best performance. Please read and understand all steps for installation and heed all warnings for use of attachment.**

### **To The New Owner**

The purpose of this manual is to assist owners and operators in installing and operating the grass catcher. Please read carefully; information and instructions furnished can help you achieve years of dependable performance.

The decals on the grass catcher are there to remind the operator about possible dangers the belt and chute can be if not used properly. These decals are not intended to be used in place of this manual but instead as an extension of this manual. These decals should not be removed or obliterated. Replace these decals if they become unreadable.

It is the OWNER’S RESPONSIBILITY to make certain all operators read and understand this manual and all decals before operating the grass catcher. It is also the OWNER’S RESPONSIBILITY to make certain that all operators are qualified and physically able individuals that are properly trained in the use of this equipment.

### **Warranty Registration**

The delivery of the warranty registration form must be completed and signed to validate your warranty protection.

As the new equipment owner, you are expected to see that the form is completed and forwarded to Hustler Turf Equipment at the time of delivery.

**IMPORTANT: Any unauthorized modification, alteration, or use of non-approved attachments voids the warranty and releases Hustler Turf Equipment from any liability arising from subsequent use of this equipment.**

### **Model and Serial Number**

Catcher model and serial number are found on the serial identification plate on the back of the blower housing unit. These numbers are required for warranty registration form.

**Parts and Service**

Use original Hustler replacement parts ONLY. These parts are available through your local Hustler dealer. To obtain prompt, efficient service, always provide the following information when ordering parts:

1. Correct part description
2. Correct model number
3. Correct serial number

All warranty repair and service must be handled through an authorized Hustler dealer. Arrangements should be made through your local service center.

For location of nearest dealer, or should you need further assistance, contact:

Customer Service Department  
Hustler Turf Equipment  
P.O. Box 7000  
Hesston, KS 67062  
Telephone (620) 327 – 4911  
FAX (620) 327 – 2458  
Web site: [www.hustlerturfequipment.com](http://www.hustlerturfequipment.com)

Please register warranty immediately upon purchase.

**GRASS CATCHER ATTACHMENT  
HUSTLER TURF CONSUMER PRODUCT  
ONE YEAR FULL WARRANTY FOR RESIDENTIAL USE  
(90 DAY LIMITED WARRANTY FOR COMMERCIAL USE)**

**WHAT IS COVERED BY THIS WARRANTY**

Hustler Turf Equipment makes the following warranty to the original purchaser only:

- a. **Residential use:** Hustler Turf Equipment used for normal residential purposes\* are warranted for one (1) year **from date of purchase** on materials and workmanship.

If the purchaser discovers within this warranty period (one year from the date of purchase) a defect in workmanship or materials:

- He must promptly notify Hustler Turf Equipment or an authorized dealer, in writing of the defect. In no event shall notification be received by Hustler Turf Equipment, or an authorized dealer later than thirteen (13) months from date of purchase.
- Within reasonable time after such notification, Hustler Turf Equipment, will correct any defect in material or workmanship on the Hustler Turf Equipment, by repairing or replacing part(s) with either new or used replacement parts.
- Such repair, including parts and labor shall be at the expense of Hustler Turf Equipment.

**\*Normal residential purpose means use of products on same lot as your home.** Use at more than one location is considered commercial use, and then the commercial use warranty would apply.

- b. **Commercial Use:** Hustler Turf Equipment used for commercial, institutional, or rental use is warranted for **90 days from date of purchase** on all material and workmanship (Rental use is warranted for 90 days).

If the purchaser discovers within this warranty period a defect in material or workmanship:

- He must promptly notify Hustler Turf Equipment, or an authorized dealer, in writing of the defect. In no event shall Hustler Turf Equipment or an authorized dealer receive notification later than 120 days after date of purchase.
- Within reasonable time after such notification, Hustler Turf Equipment, will correct any defect in material or workmanship on the Hustler Turf Equipment, by repairing or replacing part(s) with either new or used replacement parts.
- Such repair, including parts and labor shall be at the expense of Hustler Turf Equipment.

**WHO MUST PERFORM THE WARRANTY SERVICE**

Dealers authorized by Hustler Turf Equipment will perform all warranty service.

**The owner of the product will pay Service calls and/or transportation expense of the product to and from authorized dealer, for warranty work.**

For warranty service you can contact an authorized dealer or write Hustler Turf Equipment, 200 South Ridge Road, Hesston, Kansas 67062, or call 1-620-327-4911.

**WHAT IS NOT COVERED BY THE WARRANTY**

Hustler Turf Equipment does not warranty:

- Repairs made by unauthorized persons
- Damage caused by use of the Hustler Turf Equipment for purpose other than it was designed
- Damages caused by disasters such as flood, fire, wind, lightning, ECT...
- Damage caused by neglect, abuse, abnormal use, improper or unreasonable use, accident, negligence or misuse.
- Repair or replacement resulting from the use of unauthorized parts, accessories or attachments.
- Repairs or replacements as a result of alterations or modification, in determination by Hustler Turf Equipment, which adversely affects the operation, performance or durability of the equipment.
- Hustler Turf Equipment which has the serial number removed or made illegible
- Depreciation or damage caused by normal wear, lack of reasonable and proper maintenance, failure to follow product's owner's manual

operating, maintenance and adjustment instructions or other operational instructions provided by Hustler Turf Equipment.

- Normal maintenance parts and service including, but not limited to belts, etc.
- Failure to follow owner's manual and warranty for your Hustler Turf Equipment tractor.

**DISCLAIMER OF WARRANTY**

**The forgoing warranties are in lieu of all other warranties, expressed or implied, including but not limited to the implied warranties of merchantability and fitness for a particular purpose. However, if the Hustler Turf Grass catcher is purchased as a consumer product, any implied warranty of merchantability or fitness for a particular purpose is limited to the duration of this limited warranty. Some states do not allow limitations on how long and implied warranty lasts, so the about limitations may not apply to you. This warranty gives you specific legal rights, and you may also have other rights, which vary from state to state.**

**LIMITATION OF REMEDIES**

In no case shall Hustler Turf Equipment, be liable for any special, incidental, or consequential damages based upon breach of warranty, breach of contract, negligence, strict liability in tort, or any other legal theory.

Such damages include, but are not limited to:

- Loss of profit
- Loss of saving revenue
- Loss of use of Hustler Turf Equipment or any associated equipment
- Cost of capital
- Cost of any substitute equipment, facilities, service, or downtime
- The claims of third parties including customers, and injury to property

Some states do not allow the exclusion or limitation of incidental or consequential damages, so the above limitation or exclusion may not apply.

**THE LIMITS**

Any action of breach of warranty must be commenced within thirteen (13) months following purchase date in a residential application. Any action for breach of warranty must be commenced within 120 days following purchase date in a commercial or rental application.

**NO OTHER WARRANTIES**

Unless modified in writing, signed by both parties, and approved by the President of Hustler Turf Equipment, this agreement is understood to be the complete and exclusive agreement between the parties, superseding all prior agreements, oral or written, and all other communications between the parties relating to the subject matter of this agreement. No employee of Hustler Turf Equipment, or any other party is authorized to make any warranty in addition to those made in this agreement.

**OWNERS RESPONSIBILITY**

You must maintain your Hustler Grass catcher by following proper usage described in owner's manual.

**This grass catcher like any other powered equipment is potentially dangerous unless properly operated.** Any operator must be cautious and keep safety in mind at all times. Any operator, prior to attaching and using the Hustler Grass catcher, should thoroughly familiarize themselves with the owner's manual regarding operations, procedures and safety of the machine, person, and person's around the area of grass catcher, as well as safety warnings on the grass catcher itself.

**WARRANTY REGISTRATION**

1. The warranty registration form must be completed and signed by the authorized dealer and original purchaser.
2. For validation, the completed warranty registration for **MUST** be forwarded to Hustler Turf Equipment within ten (10) days following date of purchase.
3. The date of purchase constitutes start of warranty.

## SAFETY PRECAUTIONS



This safety alert symbol is used to call attention to a message intended to provide a reasonable degree of **PERSONAL SAFETY** for operators and other persons during the normal operation and servicing of this equipment.

**DANGER** – denotes immediate hazards, which **WILL** result in severe personal injury or death.

**WARNING** – denotes a hazard or unsafe practice, which **COULD** result in severe personal injury or death.

All operators should read this manual, or be instructed about safe operating and maintenance procedures. This is the owner's responsibility.

Incorrect usage of this machine may result in severe injury. It is the owner's responsibility that all operators read this manual thoroughly and be properly trained in operation and maintenance before attempting to set-up, adjust, or service this machine. This owner's manual contains many safety precautions that must be followed to avoid injury.



**WARNING:** The Battery and Engine Exhaust contains chemicals known to the state of California to cause cancer, birth defects or other reproductive harm. The battery and post contains lead; wash hands after using.



**DANGER:** This machine was built to be operated according to the rules for safe operation in this manual. As with any type of power equipment, carelessness and error on the part of the operator can result in serious injury. This machine is capable of amputating hands and feet and throwing objects. Failure to observe the following safety instructions could result in serious injury or death.

### TRAINING

1. Read, understand and follow all instructions on the machine and manual before attempting to assemble or operate. Keep this manual in a safe place for reference and for ordering replacement parts.
2. Be familiar with controls and their proper operation. Know how to stop the machine and disengage quickly.
3. Never allow children to operate the machine.
4. Never allow adults to operate this machine without them being a qualified and physically able individual, properly trained in the operation of this equipment. .
5. Thrown objects can cause serious personal injury. Turn mower off before opening top.
6. Exercise caution while operating tractor with this attachment, especially when traveling in reverse.

### PREPARATION

1. Disengage mower deck before starting engine
2. NEVER attempt to make any adjustments while engine is running.
3. To avoid personal injury or property damage use extreme caution when handling gasoline. Gasoline is extremely flammable and vapors are explosive. Serious personal injury can occur when gasoline is spilled on yourself or cloths, which can ignite. Wash your hands and change cloths immediately.
  - a. FOLLOW ALL RECOMMENDATIONS IN YOUR HUSTLER OWNERS MANUAL FOR HANDLING OF GASOLINE.

### OPERATION

1. Do not put hands or feet near rotating parts, in the blower housing or discharge chute. Contact with the rotating parts can amputate hands and feet.
2. Never work on blower assembly or mower deck when the tractor engine is running.
3. Always operate with complete catcher system or discharge chute in place.
4. Always keep safety shields and covers in place while operating the machine.
5. Never operate with missing or damaged discharge chute. Keep all safety devices in place while working.
6. Never run an engine indoors or in a poorly ventilated area. Engine exhaust contains carbon monoxide, an odorless and deadly gas.
7. Do not operate machine while under the influence of drugs or alcohol.
8. Do not touch muffler or engine
9. Do not carry passengers.
10. Exercise caution when changing direction or operating on a slope
11. Never operate this machine without good visibility or light.
12. Disengage power to the deck when not in use
13. Always use caution when going in reverse.
14. If machine to start to vibrate abnormally, stop the engine, disengage the deck, inspect for damage. Repair any damage before starting and operating.

15. Never leave a running machine unattended. Always disengage the mower deck clutch, place control levers in park brake position, stop tractor engine, and remove ignition key when leaving operator's seat. Wait until all belts come to a COMPLETE stop before using a probe to unclog the discharge chute, making any adjustments or inspecting the machine.
16. Never put your hands in the discharge chute when mower deck is engaged.
17. If a situation occurs that is not covered in this manual, use care and good judgment. Contact your Hustler dealer immediately.
18. Never work on blower assembly or mower deck when the tractor engine is running.

## MAINTENANCE AND STORAGE

1. Never tamper with safety devices
2. Disengage mower deck clutch, place control levers in park brake position, turn the engine off and remove the key to prevent unintended starting.
3. Check bolts and screws for proper tightness at frequent intervals to keep machine in safe working condition.
4. Maintain and replace safety and instruction labels as necessary.
5. Follow all maintenance and storage instructions from your Hustler Tractor Owner's manual.



### WARNING—YOUR RESPONSIBILITY

Restrict the use of this power machine to persons who can read, understand and follow the warnings and instructions in this manual and on the machine.



REPLACE THESE DECALS IMMEDIATELY IF THEY BECOME UNREADABLE OR DAMAGED.



PART NUMBER: 727420

PART NUMBER: 782219

# ATTACHING THE CATCHER FRAME TO FASTRAK HONDA AND KOHLER BUMPER

Attaching frame to **HONDA** engine bumper

## Step One

- Put frame together. Use (2) 3/8 x 1 3/4 bolt, washer, and nut
- Make sure the lip is facing down to attach to side of frame where arms are pointing up

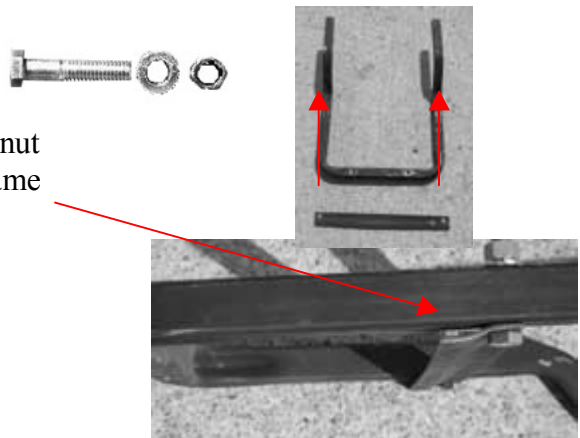

## Step Two

Parts and tools needed:

- Drill with 13/32 bit
- (2) 3/8 x 1 3/4 bolt, washer and nut
- Grass catcher frame assembled

To do:

- Set frame on bumper of FasTrak. **Make sure bumper is in the rearmost position.** The lip should be over the top of the bumper and as far right as possible
- Drill holes through bumper as shown in picture
- Attach frame with bolt, washer and nut

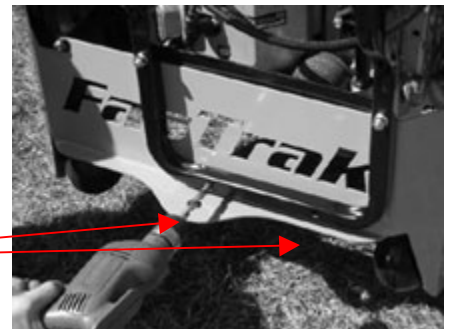

Attaching frame to **KOHLER** engine bumper

## Step One

Parts and tools needed:

- Drill with 13/32 bit
- (4) 3/8 x 1 3/4 bolt, washer and nut
- Grass catcher frame and frame brace

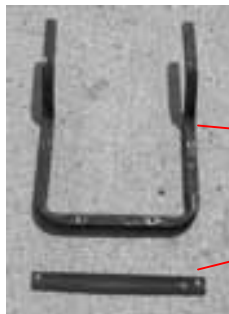

To do:

- Set frame on bumper as far right as possible
- Drill 4 holes through bumper
- Use bolt, washer and nut to attach bottom of frame
- When attaching top part of frame to bumper put brace inside bumper and:
  - Put bolts through frame, bumper and brace
  - Put washer and nut on and tighten

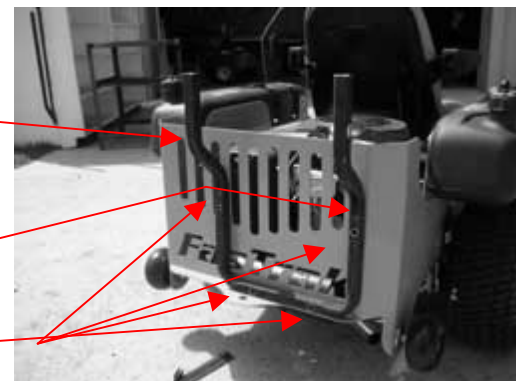

THE REST OF THE INSTALLATION IS THE SAME FOR BOTH THE **HONDA** AND **KOHLER**

### **Step Three**

Attaching brace to frame and tractor

Parts needed:

- Brace
- (1) 3/8 x 1 3/4 bolt, washer and nut
- Two 9/16 wrenches

To do:

- Attach brace to outside of grass catcher frame
- Remove bolt from Hustler frame by gas tank
- Reinsert bolt with brace attached using second hole on brace

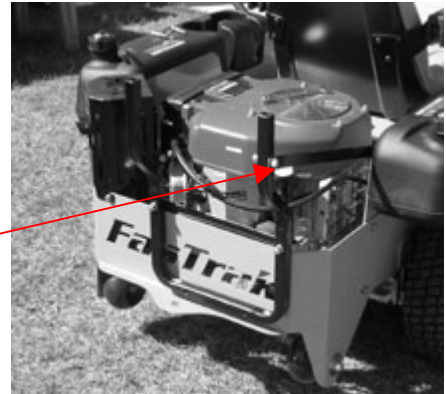

### **Step Four**

Insert bag holder frame

- Insert bag holder frame into main frame



### **Step Five**

Parts needed:

- Grass catcher hood
- (2) 1/4 x 1" hex head bolts, and nuts

To do:

- Put hood on top of frame.
- Insert bolt through hood brace and frame
- Attach nut and tighten

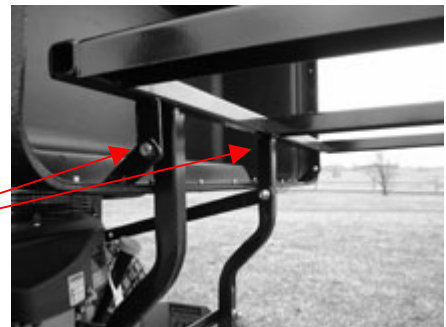



## MINI Z—ATTACHING THE FRAME

### Step One

To do:

- Put frame together. Use (2) 3/8 x 1 3/4 bolt, washer, and nut
- Make sure the lip is facing down to attach to side of frame where arms are pointing up

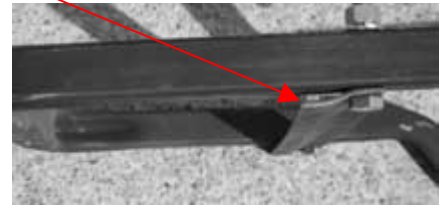
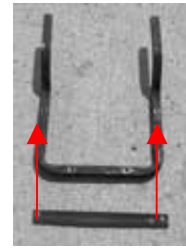

### Step Two

Parts and tools needed:

- Drill with 13/32 bit
- (2) 3/8 x 1 3/4 bolt, washer, and nut
- Grass catcher frame assembled

To do:

- Set frame on bumper of Mini Z. The lip should be over the top of the bumper and as far right as possible
- Drill holes through bumper as shown in picture
- Attach frame with bolt, washer, and nut



### Step Three

Parts and tools needed:

- Brace
- (2) 3/8 x 1 3/4 bolt, washer, and nut
- Two 9/16 wrenches

To do:

- Attach brace to **INSIDE** of grass catcher frame with bolt, washer and nut
- Remove nut from inner frame as shown in picture
- Use first hole on brace
- Attach brace to frame by retightening nut

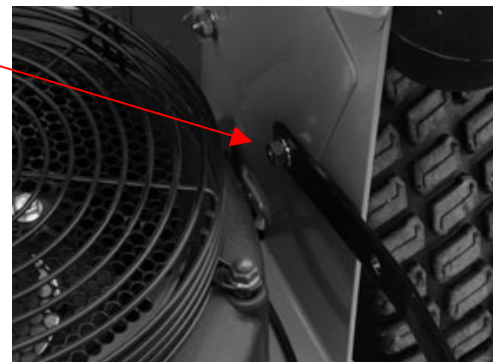
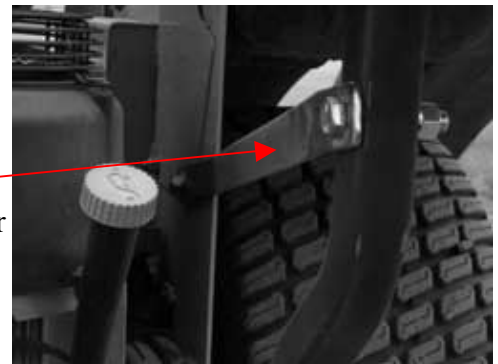

### Step Four

Parts needed:

- Bag holder frame

To do:

- Put bag holder frame onto main frame

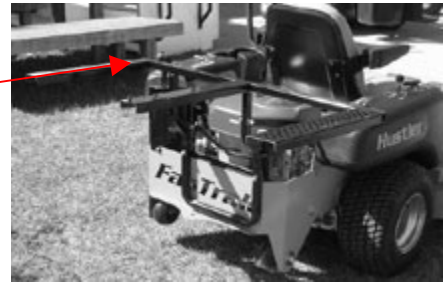

### Step Five

Parts needed:

- Grass catcher hood
- (2) ¼ x 1" bolts and nuts



To do:

- Put hood on top of frame.
- Insert bolt through hood brace and frame
- Attach nut and tighten

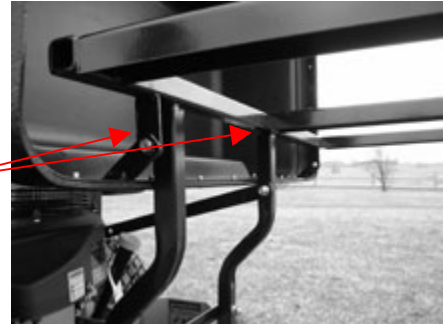

## ATTACHING THE PULLEY/ DECK STOP

Parts and tools needed

- 3" Pulley
- Deck stop
- 15/16 socket with breaker bar
- Block of wood

### Step One

Remove cover, chute, and pulley bolt

To do:

- Loosen and remove knobs and cover (FasTrak will need ½" wrench to remove cover) Knob or bolt will be used to attach deck stop

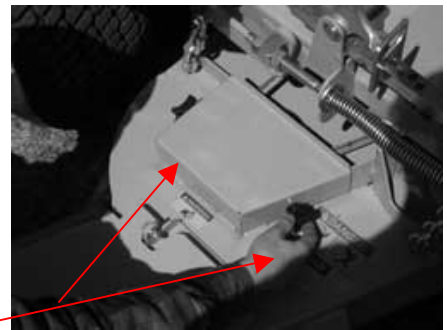

Remove chute:

- **Older Deck:** Mounting bolts are welded on mower deck. Only remove nut and washer and keep all hardware for use in attaching blower.
- **Newer Decks:** Mounting bolts are not welded on mower deck and will be replaced with 1" bolts (from bolt packet) when mounting blower. Keep washer and nut to mount blower.



Remove pulley bolt:

- Use socket with breaker bar and block of wood
- Stick block of wood in deck housing to help remove bolt from pulley. Turn nut counter clockwise to loosen and remove

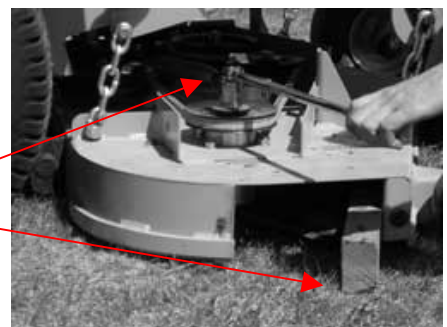

## Step 2

### Install deck stop on **FasTrak Only**

- Using bolt removed from pulley cover. Deck stop goes on outside of deck frame.
- It will be fastened through hole that fits the 44" or 52" deck.
- Mower deck stop will not allow deck height to reach transport mode

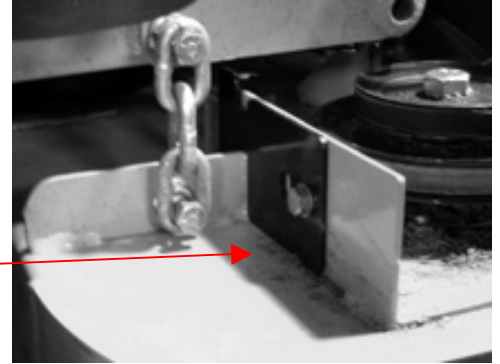

## Step 3

- Add 3" pulley for blower. Use 15/16 socket with a breaker bar

TORQUE 118ft. lbs.

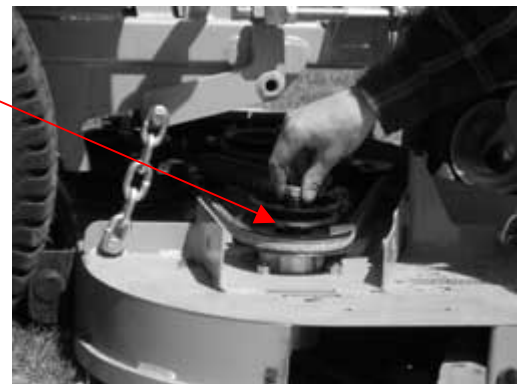

## CUTTING AND ATTACHING THE BLOWER HOUSING

### Cutting the blower housing

The blower comes ready for a 44" FasTrak deck. The cut lines are shown on the sticker attached to housing for the FasTrak 52" deck and Mini Z's 44" and 52" deck.

Tools needed:

- Jig saw

Cut out blower housing by following color coordinated stickers.

Mini Z 44"- yellow section

FasTrak 52"- red & yellow section

Mini Z 52"- yellow, red and white section

- FasTrak 52" (red & yellow)
- Mini Z 52" (red, white & yellow)
- Mini Z 44" (yellow)

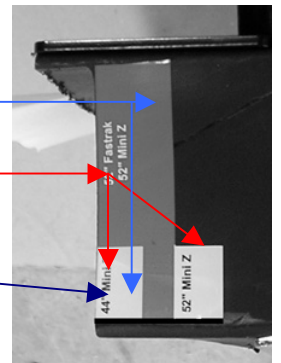

ONLY CUT OUT AROUND STICKER. LIP MUST REMAIN UNCUT.  
(FasTrak 52" deck is shown)

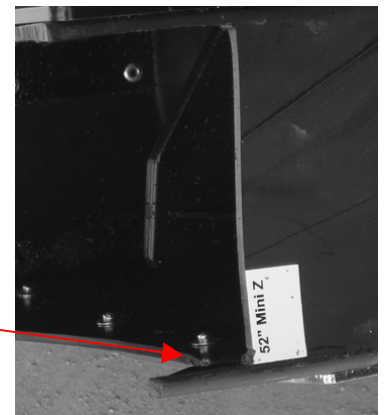

## ATTACHING HOUSING, PULLEYS, AND BELT

Parts and tools needed:

- Housing
- Large washers (2)
- Template for deck cutting
- Deck cutting tool: i.e. grinder, jigsaw

### Step One (Newer decks will already be cut)

- Cut out deck using your choice of deck cutting tool
- Trace pattern given on back of manual
- Cut out the following pattern starting from top left side

### Step Two

Attach housing to deck

- Put housing on deck
- Attach housing using small washer, nut (removed from deck) large washer, and 1" bolt from bolt pack if bolts are not welded on deck. (welded bolts apply to older decks)

**Make sure large washer is on the bottom.**

**ATTENTION:** Housing will not line up straight on deck. It will be angled from left to right in order for the back of the blower to be flush with the deck.

Back of manual

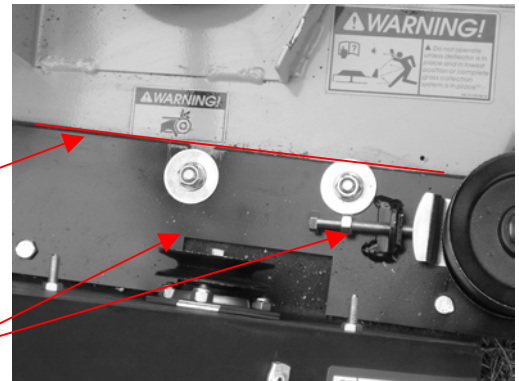
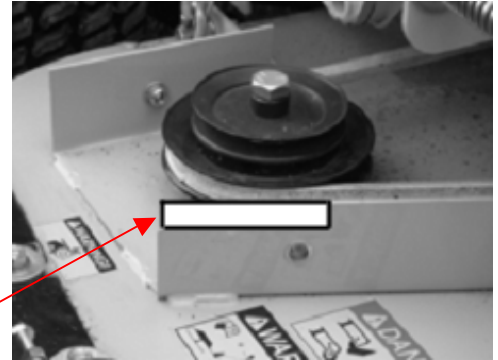

### Step Three

Attach belt to pulleys:

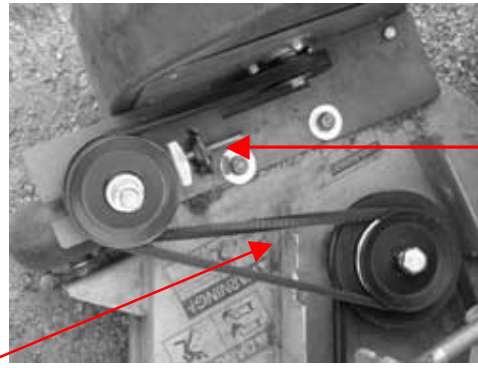
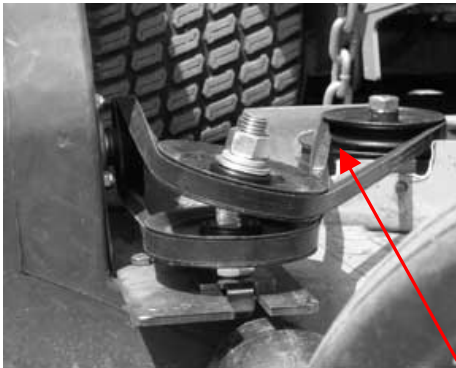

Belt tightener bolt

- Belt tread should always be touching the pulleys. Belt will be twisted when coming from main pulley to housing's lower pulley.
- IF BELT IS PUT ON INCORRECTLY IMPELLER WILL ROTATE IN THE WRONG DIRECTION. Looking from the right side, the impeller should rotate counterclockwise.
- Once belt is on, tighten with belt tightener bolt. (To tighten belt, hook one end of measuring device to the outer edge of the deck cover brace. Angle so the tape measure is perpendicular to the belt and also located approximately half way between the two pulleys. The belt should only deflect 1/2" with 8lbs of force exerted on it. If it deflects more than 1/2" then you need to tighten bolt some more.)



## MOUNTING OF PULLEY GUARD (Comes pre-cut for 52" deck)

Parts needed:

- (2) wing nuts
- pulley guard

### **44" DECK CUT OUT**

- Turn belt guard over
- Cut out following cut lines

### Step 1

- Mount pulley guard on blower housing as shown
- Two braces will go through the two bolts on blower
- Use wing nuts to tighten into place

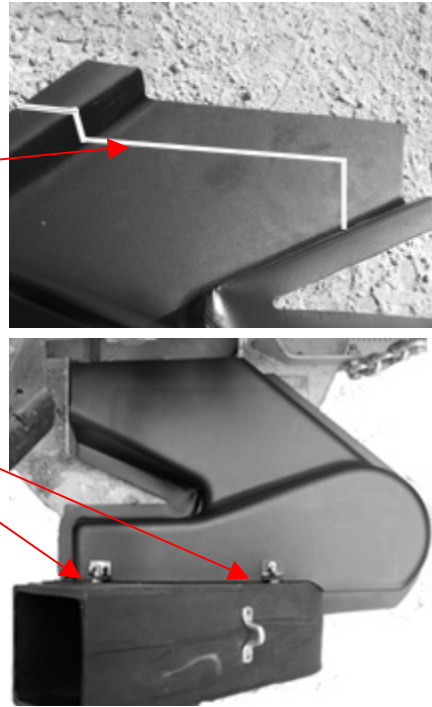

## ATTACHING THE CHUTE TO HOUSING AND COVER

Parts and Tools needed:

- Drill and 9/32 drill bit
- (2) 7/16 wrenches
- (1) 1/4 x 1 bolt and nyloc nut



### Step 1

To do:

- Insert upper grass chute into bagger cover  
Bottom shoulder of chute should be 1" from  
Bottom of lid

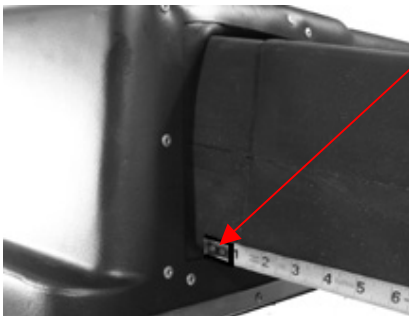

### Step 2

To do:

- Insert lower chute into upper chute and onto blower

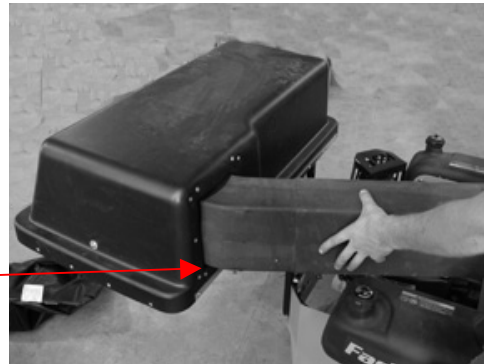

### **Step 3**

To do:

- Attach S-hook on lower chute to housing.

### **Step 4**

To do:

Connecting chute with bolt and nyloc nut

#### **How to measure were to drill hole on chutes**

- Measure 39 inches from bottom of lower chute
- Drill hole with 9/32 drill bit through both chutes on one side
- Insert  $\frac{1}{4}$  x 1" bolt and attach nyloc nut.

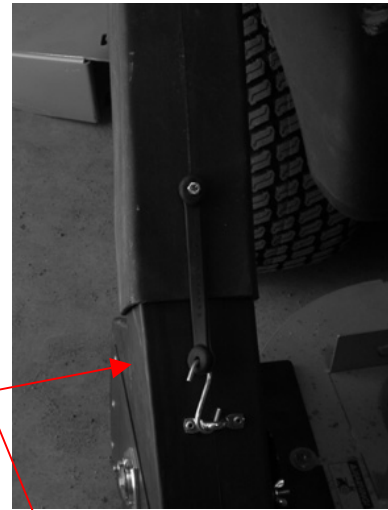

**Head of bolt must be on inside of chute and nut on the outside**

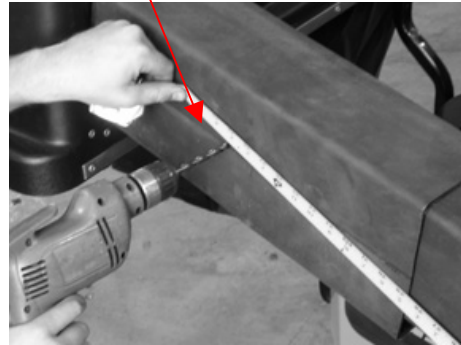

threads

nut

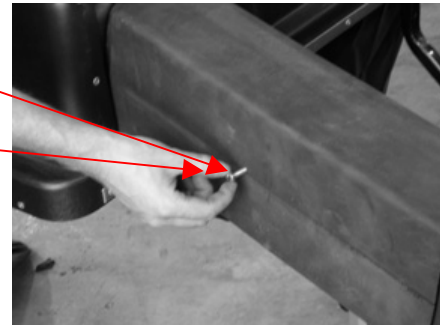

## • Operation



**Warning:** Read, understand, and follow all instructions and warnings on the tractor, attachment, and in the tractor and catcher Owner's Manuals before operating.

- Become familiar with and comfortable using your entire Hustler controls as instructed in your Owner's Manual before operating it with the grass catcher attachment.
- Make certain the correct weight of motor oil is in your tractor's engine as instructed in your owner's manual.
- Always operate the grass catcher with the engine at high rpm's
- NEVER override any safety feature on either your tractor or grass catcher.
- Make sure that all nuts, bolts, and hardware are fastened securely and tight on both the Hustler and grass catcher attachment prior to use.
- Make certain the grass catcher is assembled properly and mounted to the Hustler as instructed in the Owner's Manual.
- Test all controls for proper operation prior to operating the grass catcher.
- Never place hands or feet into blower housing. There is an impeller located inside the housing that will cause severe injury.
- Never engage the mower deck unless hose is clamped in place on blower outlet.
- If the chute becomes jammed with grass, immediately disengage deck, place control lever in the park brake position, shut off engine, remove the key, and wait for blower to stop before unclogging. Always use a rod or stick to unplug blower housing or chute. Use a probe to clean debris from blower and spout.

•

# PARTS LIST

## Blower housing

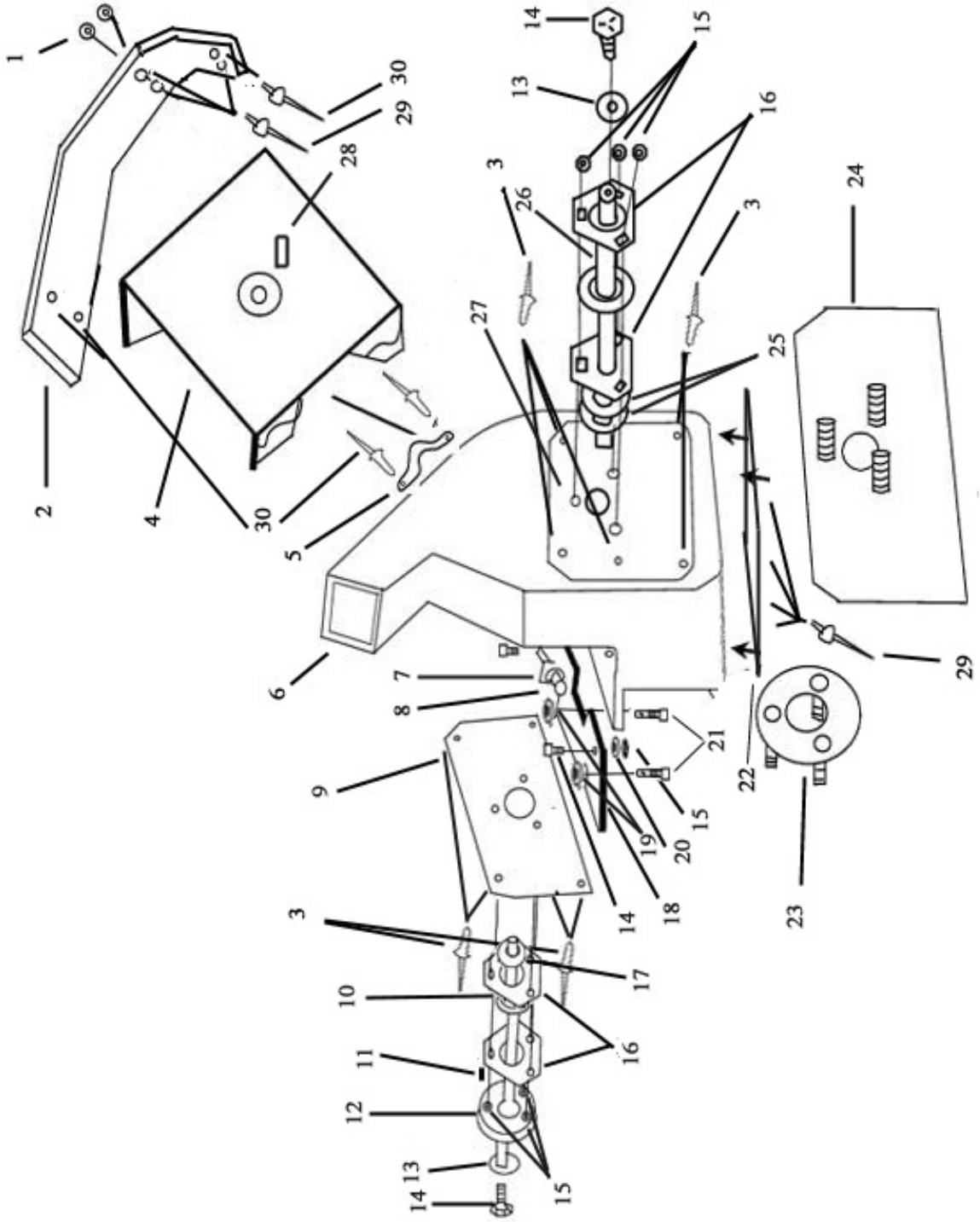



## PARTS LIST BLOWER HOUSING DRAWING

DRAWING #	PART#	TYPE	DESCRIPTION
1	798439	HARDWARE	RIVET WASHER
2	104224	BLOWER	INSIDE GRASS GUIDE
3	760140	HARDWARE	3/16 .251-.375 GRIP (ALUM)
4	798033	BLOWER	IMPELLER
5	798181	HARDWARE	ANCHOR LOOP
6	798025	BLOWER	BLOWER HOUSING
7	003272	HARDWARE	NC NUT 5/16"
8	798249	HARDWARE	FULL THREAD BOLT 5/16 x 3"
9	104414	PLATE	OUTSIDE SUPPORT PLATE
10	798199	BEARING	BEARING 3/4" BORE/ 47MM
11	798207	KEY	KEY 3/16" SQ X 1/2"
12	798165	PULLEY	KEYED 3" O.D. X 3/4" I.D. -A-SEC.
13	768523	HARDWARE	FLAT WASHER 5/16"
14	034280	HARDWARE	HEXHEAD BOLT 5/16" X 3/4"
15	058776	HARDWARE	NY LOCK NUT 5/16"
16	798223	FLANGETTE	TRIANGLE FLANGETTE 3 HOLE/ 47MM
17	798447	HARDWARE	14 GA MACHINE BUSHING
18	104232	PLATE	MOUNTING PLATE
19	079202	HARDWARE	FENDER WASHERS 5/16" X 1 1/4"
20	798264	HARDWARE	FENDER WASHERS 3/8"
21	036244	HARDWARE	CS .375-16X1.00 HX G5
22	104448	PLATE	BOTTOM MOUNTING PLATE
23	104265	FLANGETTE	ROUND FLANGETTE 3 HOLE/ 47MM
24	104257	PLATE	INSIDE SUPPORT PLATE
25	798272	HARDWARE	FLAT WASHER 3/4" -10 GAU MACH BUSH
26	798231	SHAFT	KEYED SHAFT 3/4 O.D. X 6 1/4"
27	104406	PLATE	OUTSIDE SUPPORT PLATE
28	798215	KEY	KEY 3/16" SQ X 2"
29	798751	HARDWARE	3/16 .251-.375 GRIP (SS)
30	798843	HARDWARE	3/16 .376-.500 GRIP (SS)

# PARTS LIST

## Frame

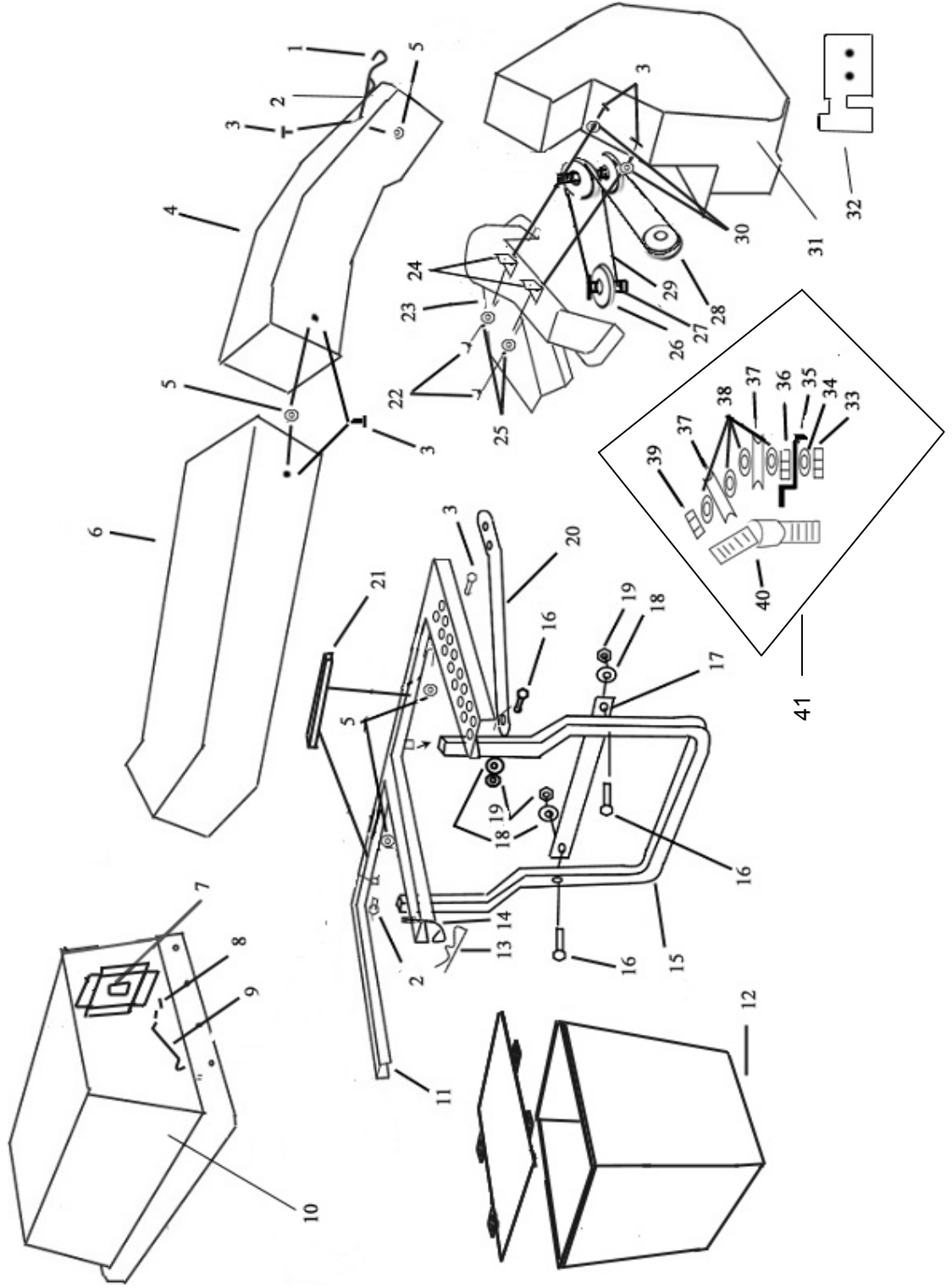

## PARTS LIST FRAME DRAWING

DRAWING #	PART#	TYPE	DESCRIPTION
1	798108	ANCHOR	S-HOOK
2	798330	BUNGEE	BUNGEE CORD
3	056077	HARDWARE	HEX HEAD BOLT 1/4 X 1"
4	798041	BLOWER	LOWER GRASS TUBE
5	068551	HARDWARE	NY LOCK NUT 1/4"
6	798058	BLOWER	UPPER GRASS TUBE
7	798116	BLOWER	RUBBER FLAP
8	008063	HARDWARE	COTTER PIN
9	104174	COVER	PROP ROD
10	798066	COVER	COMPLETE LID
11	104299	FRAME	MAIN FRAME WELDEMENT
*12	798074	BLOWER	BAGS
13	017301	HARDWARE	HAIR PIN
14	798322	COVER	LANYARD
15	104273	FRAME	BUMPER FRAME
16	705178	HARDWARE	NC BOLT 3/8 X 1 3/4
17	104182	FRAME	FRAME ATTACH BRACKET
18	001712	HARDWARE	LOCK WASHER 3/8"
19	054502	HARDWARE	NC NUT 3/8"
20	104281	FRAME	FRAME BRACE
21	798124	FOAM RUBBER	NEOPRENE/W ADHESIVE BACK 3/4 X 3/4 X 15"
22	798298	HARDWARE	WING NUT 1/4"
**23	104612	BELT COVER	BELT COVER LID
24	105510	BRACKET	MOUNT TAB, BELT COVER
25	025403	HARDWARE	FLAT WASHER 1/4"
26	798140	PULLEY	PULLEY3" O.D. X 5/8 I.D. -A- SEC.
27	016642	HARDWARE	NC BOLT 5/8 X 2"
28	798140	PULLEY	3" DRIVEN PULLEY
29	798132	BELT	AX BELT
30	024927	HARDWARE	NC NUT 1/4"
31	797993	BLOWER	COMPLETE BLOWER HOUSING/NO IDLER
32	104240	DECK STOP	DECK STOP
33	798827	HARDWARE	5/8 NC NYLOCK JAM NUT
34	798256	HARDWARE	FLAT WASHER 1 3/4" O.D. STANDARD
35	104216	PULLEY	PULLEY ADJUST BRACKET
36	104612	HARDWARE	NYLOCK NUT 5/8
37	798157	PULLEY	IDLER4" O.D. X 5/8 I.D. -A- SEC.
38	798306	HARDWARE	SHIM WASHER1" O.D.
39	058768	HARDWARE	NC LOCK NUT 5/8"
40	104208	PULLEY	PULLEY MOUNT BOLT
41	799452	ASSEMBLY	COMPLETE IDLER PULLEY ASSEMBLY

\*Bag with frame is part # 798082

\*\*Service part comes with mounting tabs installed



**DECK CUT OUT TEMPLATE**

